

2

1

REV	CO#	DESCRIPTION	NAME	DATE
A	001	Initial Release	DW	11/30/16
B	006	Increased distance from channel to center of hub to match holes on XS Hinge (C003-27 through C003-30).	DW	5/8/17

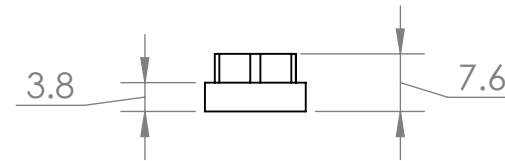
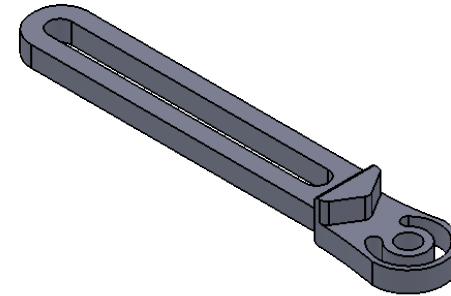
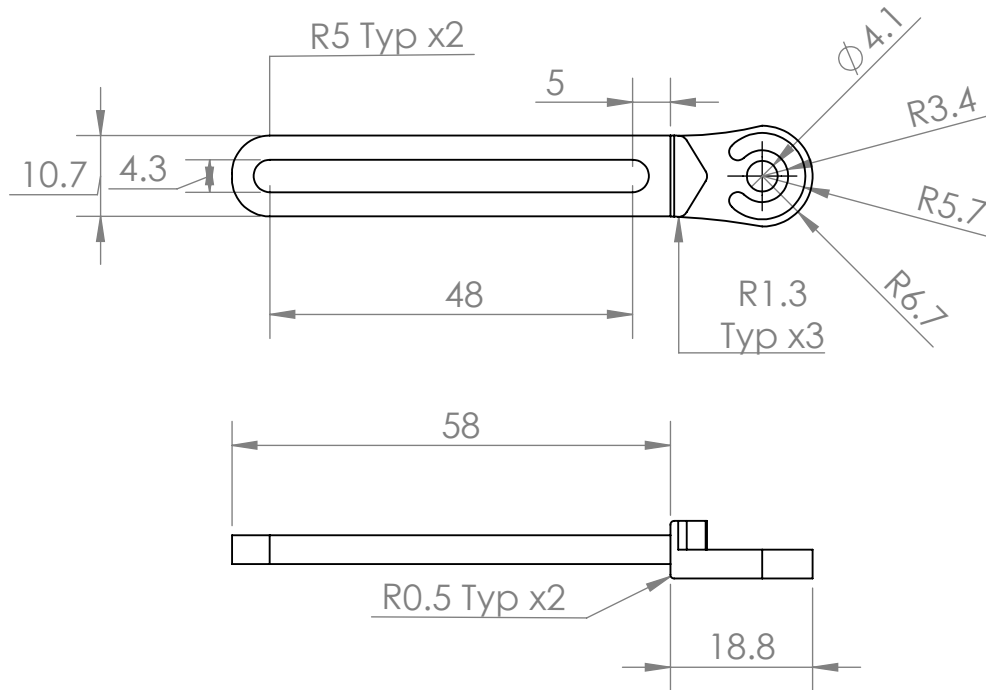

ALL DIMENSIONS IN MILLIMETERS OR DEGREES UNLESS OTHERWISE NOTED

0.1 ± 0.1
0.01 ± 0.01
0.001 ± 0.001

PART NAME:

XS Hinge - Guide - 70mm

REV:

B

P/N:

C003-24

DRAWN BY:

D Wenzel

DATE:

11/30/16



1:1

Aluminum 6061 - Anodized

2

1